



# CONSTRUCCIÓN



————— CATÁLOGO —————

PERFILES Y ACCESORIOS PARA LA CONSTRUCCIÓN

# LISANPLAST S.L.

## EXTRUSION MATERIAS PLASTICAS

### LA EMPRESA

Lisanplast es una empresa especializada en la fabricación y comercialización de perfiles obtenidos mediante extrusión y coextrusión de materias plásticas con 20 años de experiencia en el sector.

En nuestras líneas de fabricación combinamos perfiles rígidos, flexibles, coextrusión y tubos en todo tipo de diámetros interiores y exteriores.

Podemos ofrecer la transformación de cualquier tipo de termoplástico como PVC, PP, PE, ABS, PMMA, Poliuretano, Poliestireno, Termocaucho, diferentes tipos de materiales biodegradables, materiales bimatéria, etc.

**Nuestra MISION** es ofrecer a nuestros clientes la máxima calidad tanto en el producto como en el proceso de fabricación, utilizando para ello las más avanzadas tecnologías que garanticen funcionalidad y eficiencia en los procesos de nuestros clientes y que les permita obtener el rendimiento esperado en un mercado exigente y competitivo.

**El compromiso** con nuestros clientes va más allá de la oferta de nuestro amplio catálogo. Les ofrecemos asesoramiento para poder ofrecerles el producto que mejor se adapta a sus necesidades y la posibilidad de la fabricación a medida de cualquiera de ellos apoyados en nuestra dilatada experiencia en el diseño y producción de proyectos a medida.

**Nuestros productos** van dirigidos a todo tipo de sectores, siendo los principales el Sector de la Construcción y la Agricultura, pero también al sector automovilístico, de electrodomésticos, arquitectura y decoración (persianas, mamparas..etc.), señalización comercial (PLV), mobiliario y cualquier sector que demande nuestros productos.

**La comercialización** de nuestros productos se realiza en el ámbito nacional e internacional, tanto dentro como fuera de la Unión Europea y entre nuestros principales clientes contamos con multinacionales que operan a nivel mundial.

**Nuestro OBJETIVO** es ser reconocidos como una empresa líder especialista en la extrusión de materias plásticas.

**Nuestros VALORES** son la orientación al cliente, trabajo en equipo, innovación, calidad, competitividad y responsabilidad. Nuestro éxito está en desarrollar nuestro trabajo con un equipo humano dotado de una amplia experiencia y con los equipos técnicos más avanzados. Todo esto junto con el mejor servicio y una eficaz atención al cliente hacen de Lisanplast una empresa seria, que en los últimos años se ha consolidado como una de las empresas punteras en el mercado.

# ÍNDICE

## PERFILES PVC

### Perfiles para yeso, mortero y monocapa

Guardavivos PVC Monocapa pequeño  
Guardavivos PVC Monocapa exterior  
Guardavivos PVC Monocapa grande  
Junquillo Monocapa PVC  
Guardavivos PVC Yeso

# 08

## PERFILES GALVANIZADOS

### Perfiles para yeso, mortero y monocapa

Guardavivo metálico Galvanizado 4 Mallas  
Guardavido metálico Galvanizado Troquelado  
Guardavivo metálico Galvanizado Angulo Visto  
Guardavivo metálico Galvanizado Angulo Redondo  
Guardavido metálico Galvanizado Canto Pvc  
Guía Maestra metálica Galvanizado

# 11

## PERFILES PVC

### Perfiles para el encofrado

Berenjeno PVC estanco con ala (coextrusión)  
Berenjeno PVC  
Tubo Pasamuros Estriado PVC

# 16

## ACCESORIOS PARA EL ENCOFRADO

Guardacuerpos Redondo CONIX  
Base HORCAX  
Seta Protectora  
Tubo Señalización  
Chupetas (Conos Tubo)  
Tapón  
Tapón Estriado  
Tapón Multidiámetro  
Prolongación (Pasamuro)  
Distanciador Tubular  
Tapón Distanciador  
Separador Modelo Timón  
Separador De Anillas  
Separador Cuadrado  
Separador De Barra  
Calzo Para Montaje De Placa  
Modelo cubito  
Modelo Trivalente  
Modelo Reticular  
Calzo Para Montaje De Placa  
Malla plastica mortero / yeso  
Tubo flexible (goma nivel)

# 20

# 28

## PERFILES RÚSTICOS DE FIBRA VEGETAL

### Perfiles decorativos

Listero cuadrado Fibra  
Guardacanto Curvo Fibra  
Peldaño Fibra

# 31

## PERFILES PVC

### Perfiles decorativos

Guardacantos PVC

# 32

## PERFILES INOX CALIDAD 304

### Perfiles decorativos

Perfil Cuadrado Acero Inox Calidad 304  
Guardacantos Curvo Acero Inox Calidad 304  
Perfil Plano Acero Inox Calidad 304

# 34

## PERFILES ALUMINIO

### Perfiles decorativos

Guardacantos Curvo Aluminio  
Guardacantos Plano Aluminio  
Guardacantos Slim Aluminio  
Listero Aluminio canto romo  
Listero Aluminio  
Listero Slim Aluminio  
Junta Dilatación Aluminio Tipo "T"  
Recambio Junta Dilatación Aluminio Tipo "T"  
Crucetas azulejos  
Cuñas  
Separador Pavés



## PERFILES PARA YESOS, MORTEROS Y MONOCAPA

---

Son perfiles en ángulo, perfectos para proteger y reforzar todo tipo de esquinas tanto en el interior como en el exterior de la construcción.

**GUARDAVIVOS PVC MONOCAPA PEQUEÑO**

CORNER POSTS PVC MONOLAYER SMALL / POTEAUX D'ANGLE PVC MONOCOUCHE PETIT MODÈLE

REFERENCIA REFERENCE RÉFÉRENCE	MEDIDAS (mm) MEASURES (mm) MESURE (mm)	ACABADO FINISH FINITION	LONGITUD (m) LENGTH (m) LONGUEUR (m)	CAJA* BOX* BOITE*	UDS. CAJA UDS. BOX UDS. BOITE	PALETS	
						CAJAS	UDS
<b>09GVMON250</b>	31X27,5	BLANCO	2,5	Y	50	62	3100
<b>09GVMON260</b>	31X27,5	BLANCO	2,6	Y1	50	62	3100

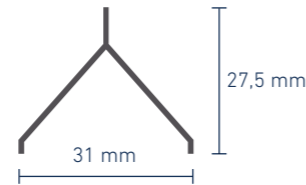

**GUARDAVIVOS PVC MONOCAPA EXTERIOR**

EDGEBANDING PVC MONOLAYER OUTSIDE

REFERENCIA REFERENCE RÉFÉRENCE	MEDIDAS (mm) MEASURES (mm) MESURE (mm)	ACABADO FINISH FINITION	LONGITUD (m) LENGTH (m) LONGUEUR (m)	CAJA* BOX* BOITE*	UDS. CAJA UDS. BOX UDS. BOITE	PALETS	
						CAJAS	UDS
<b>09GVMOE250</b>	36X29	BLANCO	2,5	D	50	48	2400

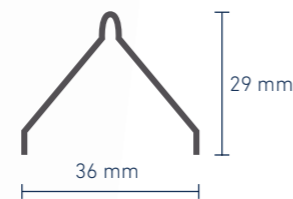

**GUARDAVIVOS PVC MONOCAPA GRANDE**

CORNER POST PVC MONOLAYER LARGE / POTEAU D'ANGLE PVC MONOCOUCHE GRAND FORMAT

REFERENCIA REFERENCE RÉFÉRENCE	MEDIDAS (mm) MEASURES (mm) MESURE (mm)	ACABADO FINISH FINITION	LONGITUD (m) LENGTH (m) LONGUEUR (m)	CAJA* BOX* BOITE*	UDS. CAJA UDS. BOX UDS. BOITE	PALETS	
						CAJAS	UDS
<b>09GVM00250</b>	42,5x29	BLANCO	2,5	B	50	48	1500

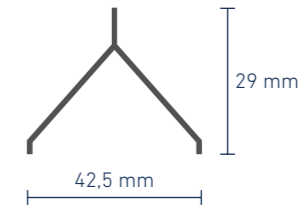

**JUNQUILLO MONOCAPA PVC**

SINGLE JONQUIL / JONQUILLE MONOCOUCHE

REFERENCIA REFERENCE RÉFÉRENCE	MEDIDAS (mm) MEASURES (mm) MESURE (mm)	ACABADO FINISH FINITION	LONGITUD (m) LENGTH (m) LONGUEUR (m)	CAJA* BOX* BOITE*	UDS. CAJA UDS. BOX UDS. BOITE	PALETS	
						CAJAS	UDS
<b>09JUNQUBLA</b>	20X7	BLANCO	2	C	130	60	7800
<b>09JUNQUBLAMINI</b>	20X4	BLANCO	2	C	220	50	11000
<b>09JUNQUBLA3CM</b>	30X7	BLANCO	2	C1	100	60	5400
<b>09JUNQUBLA4CM</b>	40X7	BLANCO	2	C2	70	60	4500

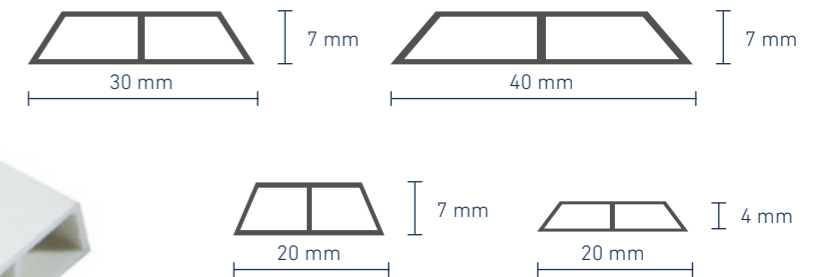

**GUARDAVIVOS PVC YESO**  
LIFEGUARD PVC PLASTER / MÂTRE NAGEUR EN PVC GYPSE

REFERENCIA REFERENCE RÉFÉRENCE	MEDIDAS (mm) MEASURES (mm) MESURE (mm)	ACABADO FINISH FINITION	LONGITUD (m) LENGTH (m) LONGUEUR (m)	CAJA* BOX* BOITE*	UDS. CAJA UDS. BOX UDS. BOITE	PALETS	
						CAJAS	UDS
<b>09GUDVS250</b>	30X24	BLANCO	2,5	100	A	62	6200
<b>09GUDVS260</b>	30X24	BLANCO	2,6	100	A1	62	6200
<b>09GUDVS270</b>	30X24	BLANCO	2,7	100	A2	62	6200
<b>09GUDVS280</b>	30X24	BLANCO	2,8	100	A3	62	6200
<b>09GUDVS300</b>	30X24	BLANCO	3	100	A4	62	6200

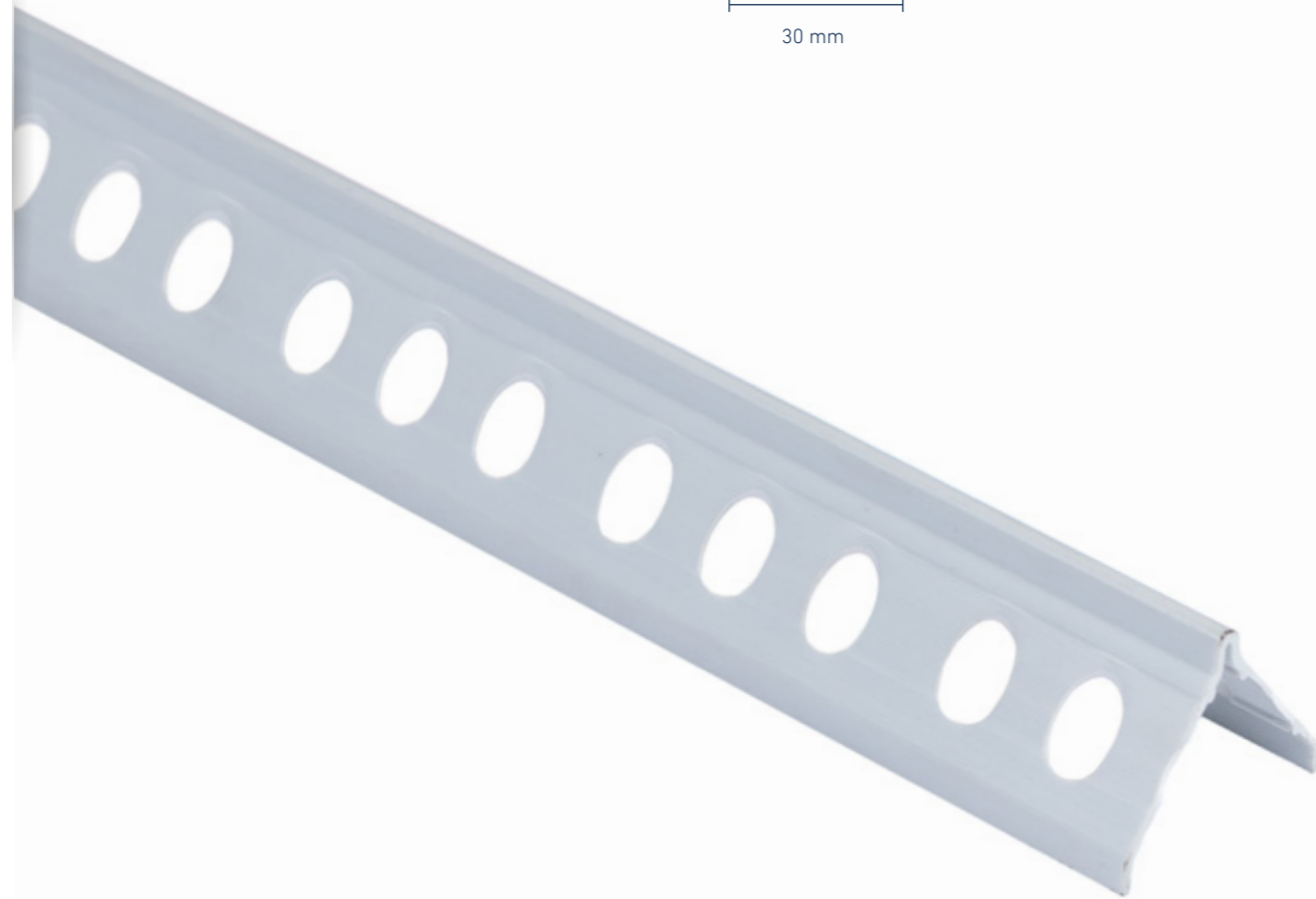
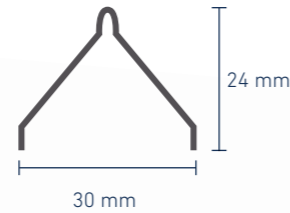

**GUARDAVIVO METÁLICO GALVANIZADO 4 MALLAS**  
GALVANIZED GUARD 4 MESH / GRILLE DE PROTECTION GALVANISÉE À 4 MAILLES

REFERENCIA REFERENCE RÉFÉRENCE	MEDIDAS (mm) MEASURES (mm) MESURE (mm)	ACABADO FINISH FINITION	LONGITUD (m) LENGTH (m) LONGUEUR (m)	FARDO* BOX* BOITE*	UDS. FARDO UDS. BOX UDS. BOITE	PALETS	
						PAQUETE	UDS
<b>11GVGLV250</b>	30X30	GALVANIZADO	2,5	50	F	100	5000
<b>11GVGLV260</b>	30X30	GALVANIZADO	2,6	50	F	100	5000
<b>11GVGLV300</b>	30X30	GALVANIZADO	3	50	F	100	5000



**GUARDAVIVO METÁLICO GALVANIZADO TROQUELADO**  
GALVANIZED GUARD DIE-CUT / GRILLE DE PROTECTION GALVANISÉE DÉCOUPÉE À L'EMPORTE-PIÈCE

REFERENCIA REFERENCE RÉFÉRENCE	MEDIDAS (mm) MEASURES (mm) MESURE (mm)	ACABADO FINISH FINITION	LONGITUD (m) LENGTH (m) LONGUEUR (m)	FARDO* BOX* BOITE*	UDS. FARDO UDS. BOX UDS. BOITE	PALETS	
						PAQUETE	UDS
<b>11GVGALTROQ</b>	25X25	GALVANIZADO	2,6	F	30	100	3000

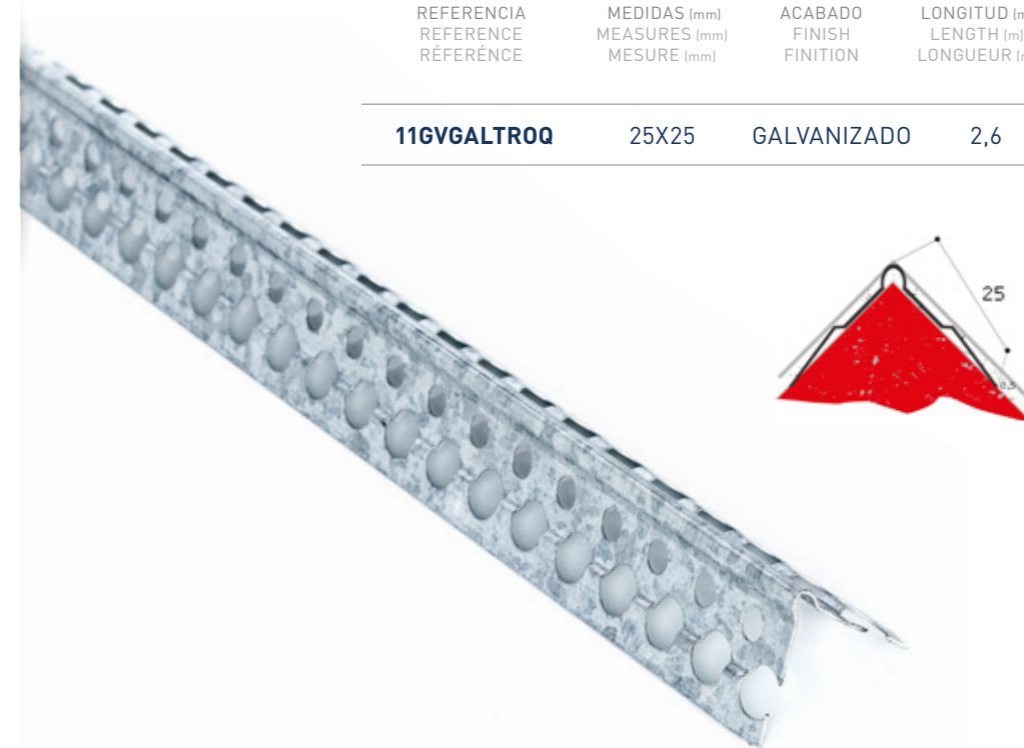

**GUÍA MAESTRA GALVANIZADO**  
GALVANIZED MASTER GUIDE / GUIDE MAÎTRE GALVANISÉ

REFERENCIA REFERENCE RÉFÉRENCE	MEDIDAS (mm) MEASURES (mm) MESURE (mm)	ACABADO FINISH FINITION	LONGITUD (m) LENGTH (m) LONGUEUR (m)	FARDO* BOX* BOITE*	UDS. FARDO UDS. BOX UDS. BOITE	PALETS	
						PAQUETE	UDS
<b>11GMGALV250</b>	6	GALVANIZADO	2,5	F	50	100	5000
<b>11GMGALV300</b>	6	GALVANIZADO	3	F	50	100	5000



**GUARDAVIVO METÁLICO GALVANIZADO ANGULO VISTO**

GALVANIZED GUARDAVIVO ANGULO VISTO / GUARDAVIVO GALVANISÉ GUARDAVIVO ANGULO VISTO

REFERENCIA REFERENCE RÉFÉRENCE	MEDIDAS (mm) MEASURES (mm) MESURE (mm)	ACABADO FINISH FINITION	LONGITUD (m) LENGTH (m) LONGUEUR (m)	FARDO* BOX* BOITE*	UDS. FARDO UDS. BOX UDS. BOITE	PALETS	
						PAQUETE	UDS
<b>11VGALVANV250</b>	30X30	GALVANIZADO	2,5	F	30	100	3000
<b>11VGALVANV260</b>	30X30	GALVANIZADO	2,6	F	30	100	3000
<b>11VGALVANV300</b>	30X30	GALVANIZADO	3	F	30	100	3000

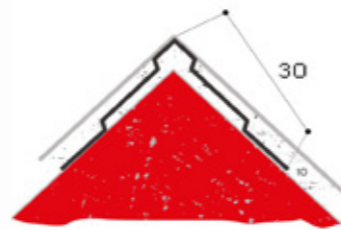

**GUARDAVIVO METÁLICO GALVANIZADO ANGULO REDONDO**  
GALVANIZED GUARD ROUND ANGLE / EQUERRE RONDE DE GARDE GALVANISÉE

REFERENCIA REFERENCE RÉFÉRENCE	MEDIDAS (mm) MEASURES (mm) MESURE (mm)	ACABADO FINISH FINITION	LONGITUD (m) LENGTH (m) LONGUEUR (m)	FARDO* BOX* BOITE*	UDS. FARDO UDS. BOX UDS. BOITE	PALETS	
						PAQUETE	UDS
<b>11VVGALVANR</b>	30X30	GALVANIZADO	2,5	F	30	100	3000

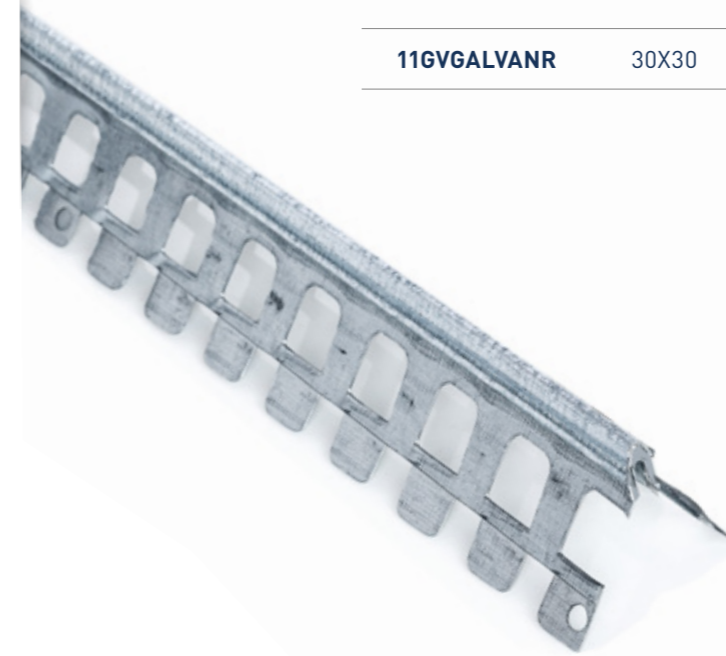
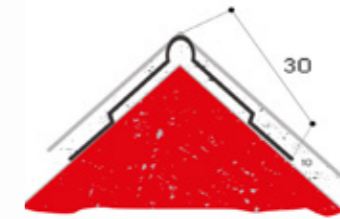

**GUARDAVIVO METÁLICO GALVANIZADO CANTO PVC**

GALVANIZED GUARDIAN PVC EDGE / BORD EN PVC GUARDIAN GALVANISÉ

REFERENCIA REFERENCE RÉFÉRENCE	MEDIDAS (mm) MEASURES (mm) MESURE (mm)	ACABADO FINISH FINITION	LONGITUD (m) LENGTH (m) LONGUEUR (m)	FARDO* BOX* BOITE*	UDS. FARDO UDS. BOX UDS. BOITE	PALETS	
						PAQUETE	UDS
<b>11VVGALVPVC</b>	30X30	GALVANIZADO	2,5	F	10	100	1000

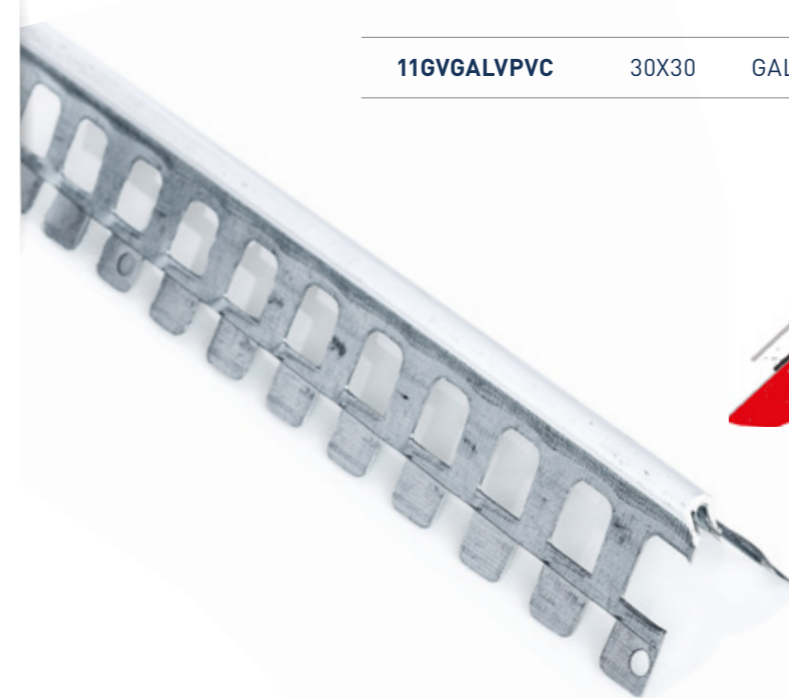
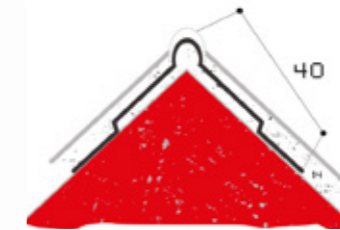



## PERFILES PARA ENCOFRADO

---

Perfiles plásticos que se colocan en los encofrados de hormigón para realizar biseles en esquinas, achaflanar ángulos, marcar juntas que definen despieces y crear goterones en el hormigón.



**BERENJENO PVC ESTANCO CON ALA**  
**AUBERGINE PVC WATERTIGHT WITH WING / AUBERGINE PVC ÉTANCHE À L'EAU AVEC AILEG**

REFERENCIA REFERENCE RÉFÉRENCE	MEDIDAS (mm) MEASURES (mm) MESURE (mm)	ACABADO FINISH FINITION	LONGITUD (m) LENGTH (m) LONGUEUR (m)	CAJA* BOX* BOITE*	UDS. CAJA UDS. BOX UDS. BOITE	PALETS	
						CAJAS	UDS
<b>09BREALA</b>	24X22	BLANCO	3	U	24	46	1104

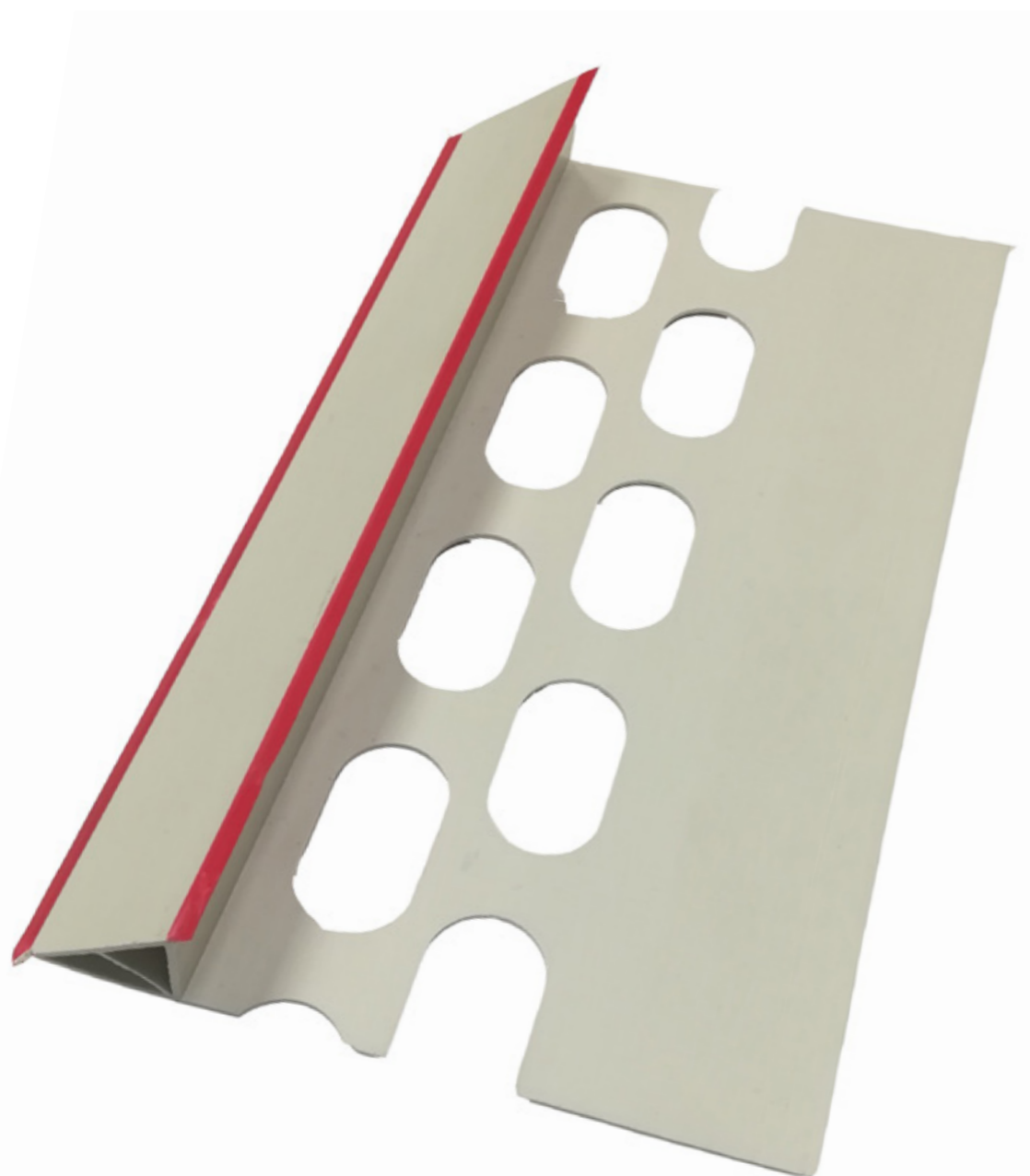
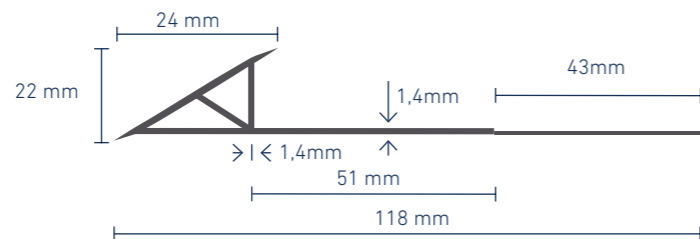

**BERENJENO PVC**  
**BERENJEN PVC / BERENJEN PVC**

REFERENCIA REFERENCE RÉFÉRENCE	MEDIDAS (mm) MEASURES (mm) MESURE (mm)	ACABADO FINISH FINITION	LONGITUD (m) LENGTH (m) LONGUEUR (m)	CAJA* BOX* BOITE*	UDS. CAJA UDS. BOX UDS. BOITE	PALETS	
						CAJAS	UDS
<b>09BREJ15</b>	12,5x2,5	NEGRO	2,5	B1	100	20	2000
<b>09BREJ20</b>	20x2,5	NEGRO	2,5	B2	50	20	1000
<b>09BREJ25</b>	25x2,5	NEGRO	2,5	B3	50	20	1000
<b>09BREJ30</b>	30x2,5	NEGRO	2,5	B4	50	20	1000



**TUBO PASAMUROS ESTRIADO PVC**  
**CORRUGATED WALL BUSHING / DOUILLE EN PVC POUR MUR ONDULÉ**

REFERENCIA REFERENCE RÉFÉRENCE	MEDIDAS (mm) MEASURES (mm) MESURE (mm)	ACABADO FINISH FINITION	LONGITUD (m) LENGTH (m) LONGUEUR (m)	CAJA* BOX* BOITE*	UDS. CAJA UDS. BOX UDS. BOITE	PALETS	
						CAJAS	UDS
<b>09TRE22x26</b>	22x26	NEGRO	2	T	25	60	3000
<b>09TRE22X26</b>	22x26	NEGRO	3	T1	25	60	4500
<b>09TRE26x30</b>	26x30	NEGRO	2	T2	20	60	2400
<b>09TRE26X30</b>	26x30	NEGRO	3	T3	20	30	3600



\*Para ver las características del modelo de caja ir a la página 40.



## ACCESORIOS PARA ENCOFRADO

---

Accesorios estandarizados adaptables a los distintos sistemas de moldeo por encofrado para todo tipo de estructuras de hormigón armado, facilitan notablemente las tareas de encofrado ofreciendo muchas ventajas en los procesos de hormigonado.

## GUARDACUERPOS BASE CILINDRICA (CONIX)

GUARDRAILS ROUND CONIX / GARDE-CORPS PONEY ROND CONIX

REFERENCIA REFERENCE RÉFÉRENCE	MEDIDAS (mm) MEASURES (mm) MESURE (mm)	MATERIAL FINISH FINITION	CAJA* BOX* BOITE*	UDS. CAJA UDS. BOX UDS. BOITE	PALETS	
					CAJAS	UDS
10BASE35	35x35 con tapa	POLIPROPILENO	R	100	60	6000
10BASE35200	35x35 con tapa	POLIPROPILENO	R	200	30	6000
10BASE35SINTAPA	35x35 sin tapa	POLIPROPILENO	R	100	60	6000



## GUARDACUERPOS BASE CUADRADA (HORCAX)

HORCAX BASE / BASE HORCAX

REFERENCIA REFERENCE RÉFÉRENCE	MEDIDAS (mm) MEASURES (mm) MESURE (mm)	MATERIAL FINISH FINITION	CAJA* BOX* BOITE*	UDS. CAJA UDS. BOX UDS. BOITE	PALETS	
					CAJAS	UDS
10BASE40	35x40	POLIPROPILENO	R2	150	NO	
10BASE60	60x40	POLIPROPILENO	R2	114	NO	
10BASE60X60	60x60	POLIPROPILENO	R2	45	30	1350
10BASE85	80x85	POLIPROPILENO	R2	64	25	1600



## SETA PROTECTORA

ROTECTIVE MUSHROOM / CHAMPIGNON PROTECTEUR

REFERENCIA REFERENCE RÉFÉRENCE	MEDIDAS (mm) MEASURES (mm) MESURE (mm)	MATERIAL FINISH FINITION	CAJA* BOX* BOITE*	UDS. CAJA UDS. BOX UDS. BOITE	PALETS	
					CAJAS	UDS
10SETAPE	10-16 varilla	POLIPROPILENO	R1	300	80	27000
10SETAPEP	10-20 varilla	POLIPROPILENO	R1	300	50	15000



## TUBO SEÑALIZACIÓN

SIGNALING TUBE / TUBE DE SIGNALISATION

REFERENCIA REFERENCE RÉFÉRENCE	MEDIDAS (mm) MEASURES (mm) MESURE (mm)	ACABADO FINISH FINITION	MATERIAL FINISH FINITION	CAJA* BOX* BOITE*	UDS. CAJA UDS. BOX UDS. BOITE	PALETS	
						PAQ.	UDS
09TBSEÑA01CR	1	NARANJA FLUORESCENTE CON REFLECTANTE	POLIPROPILENO	W	25	115	2875
09TBSEÑA01SR	1	NARANJA FLUORESCENTE CON REFLECTANTE	POLIPROPILENO	W	25	115	2875



## CHUPETAS (CONOS TUBO)

PACIFIERS (TUBE CONES) / SUCETTES (CÔNES TUBULAIRES)

REFERENCIA REFERENCE RÉFÉRENCE	MEDIDAS (mm) MEASURES (mm) MESURE (mm)	MATERIAL FINISH FINITION	CAJA* BOX* BOITE*	UDS. CAJA UDS. BOX UDS. BOITE	PALETS	
					CAJAS	UDS
10CHUPET	22	POLIPROPILENO	S	500	30	6.000
10CHUP26	26	POLIPROPILENO	S	1000	NO	



## TAPÓN

PLUG/FICHE

REFERENCIA REFERENCE RÉFÉRENCE	MEDIDAS (mm) MEASURES (mm) MESURE (mm)	MATERIAL FINISH FINITION	CAJA* BOX* BOITE*	UDS. CAJA UDS. BOX UDS. BOITE	PALETS	
					CAJAS	UDS
10TAP016	16	POLIPROPILENO	R3	1000	50	5.000
10TAP018	18	POLIPROPILENO	R3	1000	50	5.000
10TAP022	22	POLIPROPILENO	R3	1000	50	5.000
10TAP024	24	POLIPROPILENO	R3	1000	50	5.000
10TAP026	26	POLIPROPILENO	R3	500	100	5.000
10TAP032	32	POLIPROPILENO	R3	500	100	5.000



## TAPÓN ESTRIADO

GROOVED PLUG / BOUCHON RAINURÉ

REFERENCIA REFERENCE RÉFÉRENCE	MEDIDAS (mm) MEASURES (mm) MESURE (mm)	MATERIAL FINISH FINITION	CAJA* BOX* BOITE*	UDS. CAJA UDS. BOX UDS. BOITE	PALETS	
					CAJAS	UDS
10TAGE22	22	POLIPROPILENO	R3	500	100	5.000

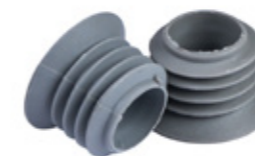

## TAPÓN MULTIDIÁMETRO

MULTI DIAMETER CAP / CAPUCHON MULTI DIAMÈTRE

REFERENCIA REFERENCE RÉFÉRENCE	MEDIDAS (mm) MEASURES (mm) MESURE (mm)	MATERIAL FINISH FINITION	CAJA* BOX* BOITE*	UDS. CAJA UDS. BOX UDS. BOITE	PALETS	
					CAJAS	UDS
10TAPOMD	22 A 32	POLIPROPILENO	R3	500	100	5.000





### PROLONGACIÓN (PASAMURO)

EXTENSION (WALL BUSHING) / RALLONGE (MANCHON MURAL)

REFERENCIA REFERENCE RÉFÉRENCE	MEDIDAS (mm) MEASURES (mm) MESURE (mm)	MATERIAL FINISH FINITION	CAJA* BOX* BOITE*	UDS. CAJA UDS. BOX UDS. BOITE	PALETS	
					CAJAS	UDS
<b>10PRDT05</b>	5	POLIPROPILENO	R	150	100	15.000

### DISTANCIADOR TUBULAR

TUBULAR SPACER / ENTRETOISE TUBULAIRE

REFERENCIA REFERENCE RÉFÉRENCE	MEDIDAS (mm) MEASURES (mm) MESURE (mm)	MATERIAL FINISH FINITION	CAJA* BOX* BOITE*	UDS. CAJA UDS. BOX UDS. BOITE	PALETS	
					CAJAS	UDS
<b>10DTTU25</b>	25	POLIPROPILENO	R2	150	25	15.000

### TAPÓN DISTANCIADOR

SPACER PLUG / BOUCHON D'ÉCARTEMENT

REFERENCIA REFERENCE RÉFÉRENCE	MEDIDAS (mm) MEASURES (mm) MESURE (mm)	MATERIAL FINISH FINITION	CAJA* BOX* BOITE*	UDS. CAJA UDS. BOX UDS. BOITE	PALETS	
					CAJAS	UDS
<b>10TAPDIS</b>	-	POLIPROPILENO	R	300	80	12.000

### SEPARADOR MODELO TIMÓN

MODEL TIMON SEPARATOR / MODÈLE SÉPARATEUR DE TIMON

REFERENCIA REFERENCE RÉFÉRENCE	MEDIDAS (mm) MEASURES (mm) MESURE (mm)	MATERIAL FINISH FINITION	CAJA* BOX* BOITE*	UDS. CAJA UDS. BOX UDS. BOITE	PALETS	
					CAJAS	UDS
<b>10TIM020</b>	20 varilla 6-12	POLIETILENO	L	1000	90	90.000
<b>10TIM025</b>	25 varilla 6-12	POLIETILENO	L1	500	104	52.000
<b>10TIM030</b>	30 varilla 6-12	POLIETILENO	L2	500	104	52.000
<b>10TIM035</b>	35 varilla 6-12	POLIETILENO	L3	250	60	24.000
<b>10TIM040</b>	40 varilla 6-12	POLIETILENO	L4	250	96	24.000
<b>10TIM050</b>	50 varilla 6-12	POLIETILENO	L5	100	104	10.400
<b>10TIM070</b>	70 varilla 6-12	POLIETILENO	L6	150	48	7.200

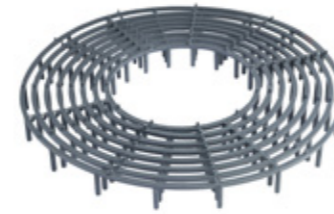

### SEPARADOR DE ANILLAS (8 AROS)

RING SEPARATOR / SÉPARATEUR À ANNEAUX

REFERENCIA REFERENCE RÉFÉRENCE	MEDIDAS (mm) MEASURES (mm) MESURE (mm)	MATERIAL FINISH FINITION	CAJA* BOX* BOITE*	UDS. CAJA UDS. BOX UDS. BOITE	PALETS	
					CAJAS	UDS
<b>10SEPREC2</b>	D 320 / A 20	POLIPROPILENO	L7	20	72	2.160
<b>10SEPREC</b>	D 320 / A 30	POLIPROPILENO	L7	20	72	1.440

\*Posibilidad de otras medidas en altura.

### SEPARADOR CUADRADO PARRILLA

SQUARE SEPARATOR / SÉPARATEUR CARRÉ

REFERENCIA REFERENCE RÉFÉRENCE	MEDIDAS (mm) MEASURES (mm) MESURE (mm)	MATERIAL FINISH FINITION	CAJA* BOX* BOITE*	UDS. CAJA UDS. BOX UDS. BOITE	PALETS	
					CAJAS	UDS
<b>10CUADRA</b>	210x100x30	POLIPROPILENO	L7	100	50	5.000

\*Posibilidad de otras medidas en altura.

### SEPARADOR PARA RETICULAR

BAR SEPARATOR / SÉPARATEUR DE BARRES

REFERENCIA REFERENCE RÉFÉRENCE	MEDIDAS (mm) MEASURES (mm) MESURE (mm)	MATERIAL FINISH FINITION	CAJA* BOX* BOITE*	UDS. CAJA UDS. BOX UDS. BOITE	PALETS	
					CAJAS	UDS
<b>10RITICULES</b>	115X45X45	POLIPROPILENO	K1	200	20	4.000

### CALZO PARA MONTAJE DE PLACA

PLATE MOUNTING CHOCK / CALE DE MONTAGE DE PLAQUE

REFERENCIA REFERENCE RÉFÉRENCE	MEDIDAS (mm) MEASURES (mm) MESURE (mm)	MATERIAL FINISH FINITION	CAJA* BOX* BOITE*	UDS. CAJA UDS. BOX UDS. BOITE	PALETS	
					CAJAS	UDS
<b>09CALZO</b>	95x90	POLIETILENO	K	130 juegos	NO	

\*Cada juego lleva 2 calzos de 2mm y 2 calzos de 4mm

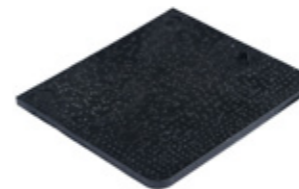

**MODELO CUBITO**  
CUBE MODEL / MODÈLE EN CUBE

REFERENCIA REFERENCE RÉFÉRENCE	MEDIDAS (mm) MEASURES (mm) MESURE (mm)	MATERIAL FINISH FINITION	CAJA* BOX* BOITE*	UDS. CAJA UDS. BOX UDS. BOITE	PALETS	
					CAJAS	UDS
<b>09H-20</b>	20	HORMIGÓN	k1	700	50	3.500
<b>09H-25</b>	25	HORMIGÓN	k2	400	50	2.000
<b>09H-30</b>	30	HORMIGÓN	k3	300	50	1.500
<b>09H-35</b>	35	HORMIGÓN	k4	250	40	1.000
<b>09H-40</b>	40	HORMIGÓN	k5	200	40	8.000
<b>09H-50</b>	50	HORMIGÓN	k6	150	45	6.750
<b>09H-60</b>	60	HORMIGÓN	k7	125	40	5.000
<b>09H-70</b>	70	HORMIGÓN	k8	100	40	4.000



**MODELO TRIVALENTE**  
TRIVALENT MODEL / MODÈLE TRIVALENT

REFERENCIA REFERENCE RÉFÉRENCE	MEDIDAS (mm) MEASURES (mm) MESURE (mm)	MATERIAL FINISH FINITION	CAJA* BOX* BOITE*	UDS. CAJA UDS. BOX UDS. BOITE	PALETS	
					CAJAS	UDS
<b>09TRI-20</b>	20X25X30	HORMIGÓN	K2	700	NO	
<b>09TRI-35</b>	35X40X50	HORMIGÓN	K7	200	NO	
<b>09TRI-45</b>	45X55X60	HORMIGÓN	K8	125	NO	



**MODELO RETICULAR**  
RETICULAR MODEL/MODÈLE RÉTICULAIRE

REFERENCIA REFERENCE RÉFÉRENCE	MEDIDAS (mm) MEASURES (mm) MESURE (mm)	MATERIAL FINISH FINITION	CAJA* BOX* BOITE*	UDS. CAJA UDS. BOX UDS. BOITE	PALETS	
					CAJAS	UDS
<b>09FR-120</b>	120	HORMIGÓN	K8	100	NO	



**MALLA MORTERO - AZUL - 90GR**

REFERENCIA REFERENCE RÉFÉRENCE	MEDIDAS (mm) MEASURES (mm) MESURE (mm)	MATERIAL FINISH FINITION	CAJA* BOX* BOITE*	MTS / ROLLO UDS. BOX UDS. BOITE	PALETS	
					ROLLOS	UDS
<b>09MAYAESTU</b>	10X10	FIBRA DE VIDRIO	W1	50	30	1.500

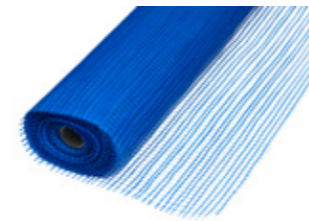

**MALLA PLÁSTICA YESO - BLANCA - 75GR**

REFERENCIA REFERENCE RÉFÉRENCE	MEDIDAS (mm) MEASURES (mm) MESURE (mm)	MATERIAL FINISH FINITION	CAJA* BOX* BOITE*	MTS / ROLLO UDS. BOX UDS. BOITE	PALETS	
					ROLLOS	UDS
<b>09MAYAYESO</b>	5X5	FIBRA DE VIDRIO	W1	50	40	2.000



**MALLA AISLAMIENTO TÉRMICO - BLANCA - (SATE) 160GR**

REFERENCIA REFERENCE RÉFÉRENCE	MEDIDAS (mm) MEASURES (mm) MESURE (mm)	MATERIAL FINISH FINITION	CAJA* BOX* BOITE*	MTS / ROLLO UDS. BOX UDS. BOITE	PALETS	
					ROLLOS	UDS
<b>09MAYASATE</b>	5X5	FIBRA DE VIDRIO	W1	50	30	1.500



**MALLA FIBRA - BLANCA - 145GR**

REFERENCIA REFERENCE RÉFÉRENCE	MEDIDAS (mm) MEASURES (mm) MESURE (mm)	MATERIAL FINISH FINITION	CAJA* BOX* BOITE*	MTS / ROLLO UDS. BOX UDS. BOITE	PALETS	
					ROLLOS	UDS
<b>09MAYA145</b>	5X5	FIBRA DE VIDRIO	W1	50	30	1.500



**TUBO FLEXIBLE TRANSPARENTE (GOMA NIVEL)**

REFERENCIA REFERENCE RÉFÉRENCE	MEDIDAS (mm) MEASURES (mm) MESURE (mm)	MATERIAL FINISH FINITION	CAJA* BOX* BOITE*	MTS / ROLLO UDS. BOX UDS. BOITE	PALETS	
					ROLLOS	UDS
<b>10TT0812</b>	8X12	PVC	X	25	60	1.500
<b>10TT1014</b>	10X14	PVC	X1	25	60	1.500





## PERFILES DECORATIVOS PARA AZULEJOS O ESQUINAS

---

**Perfiles rústicos, PVC, aluminio y acero**

Los perfiles decorativos para azulejos o esquinas son actualmente una de las tendencias estéticas más destacadas para dar el toque final a cualquier revestimiento de paredes, suelos y ambiente, combinados tanto con azulejos cerámicos como con otros materiales.

**LISTERO CUADRADO FIBRA**  
LISTERO SQUARE FIBER / LISTERO FIBRE CARRÉE



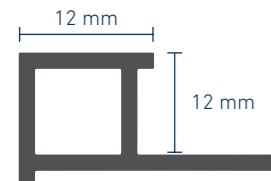





REFERENCIA REFERENCE RÉFÉRENCE	MEDIDAS (mm) MEASURES (mm) MESURE (mm)	ACABADO FINISH FINITION	LONGITUD (m) LENGTH (m) LONGUEUR (m)	CAJA* BOX* BOÎTE*	UDS. CAJA UDS. BOX UDS. BOÎTE	PALETS	
						CAJAS	UDS
091065RUSLIB	12x12	BEIS	2,6	H	50	NO	
091065RUSLIC	12x12	CARAMELO	2,6	H	50	NO	
091065RUSLIBA	12x12	BLANCO	2,6	H	50	NO	
091065RUSLIN	12x12	NEGRO	2,6	H	50	NO	
091065RUSLIBM	12x12	MARRÓN OSC.-	2,6	H	50	NO	
091065RUSLIMA	12x12	MARFIL	2,6	H	50	NO	
091065RUSLICU	12x12	CUERO	2,6	H	50	NO	
091065RUSLIG	12x12	GRIS	2,6	H	50	NO	
091065RUSLICR	12x12	CREMA	2,6	H	50	NO	











**GUARDACANTO CURVO FIBRA**  
FIBER CURVED EDGE GUARD / PROTÈGE-BORD COURBÉ EN FIBRE

REFERENCIA REFERENCE RÉFÉRENCE	MEDIDAS (mm) MEASURES (mm) MESURE (mm)	ACABADO FINISH FINITION	LONGITUD (m) LENGTH (m) LONGUEUR (m)	CAJA* BOX* BOÎTE*	UDS. CAJA UDS. BOX UDS. BOÎTE	PALETS	
						CAJAS	UDS
091065RUSBEIGE	12,0	BEIS	2,6	G	50	NO	
091065RUSCARA	12,0	CARAMELO	2,6	G	50	NO	
091065RUSBLANCO	12,0	BLANCO	2,6	G	50	NO	
091065RUSNEGRO	12,0	NEGRO	2,6	G	50	NO	
091065RUSMARRON	12,0	MARRÓN OSC.	2,6	G	50	NO	
091065RUSMARF	12,0	MARFIL	2,6	G	50	NO	
091065RUSCUERO	12,0	CUERO	2,6	G	50	NO	
091065RUSGRIS	12,0	GRIS	2,6	G	50	NO	
091065RUSCREMA	12,0	CREMA	2,6	G	50	NO	



-   
Caramelo  
RAL 8004
-   
Beige  
RAL 1011
-   
Crema  
RAL 9001
-   
Marfil  
RAL 1013
-   
Cuero  
RAL 1015
-   
Marrón oscuro  
RAL 8011
-   
Gris  
RAL 7046
-   
Blanco  
RAL 9003
-   
Negro  
RAL 9004



-   
Caramelo  
RAL 8004
-   
Beige  
RAL 1011
-   
Crema  
RAL 9001
-   
Marfil  
RAL 1013
-   
Cuero  
RAL 1015
-   
Marrón oscuro  
RAL 8011
-   
Gris  
RAL 7046
-   
Blanco  
RAL 9003
-   
Negro  
RAL 9004



**PELDAÑO FIBRA**  
STEP FIBER / MARCHEPIED FIBRE



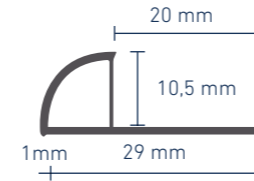
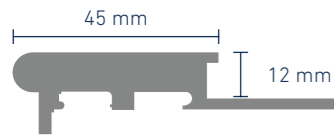





REFERENCIA REFERENCE RÉFÉRENCE	MEDIDAS (mm) MEASURES (mm) MESURE (mm)	ACABADO FINISH FINITION	LONGITUD (m) LENGTH (m) LONGUEUR (m)	CAJA* BOX* BOITE*	UDS. CAJA UDS. BOX UDS. BOITE	PALETS	
						CAJAS	UDS
091065RUSPELB	45x12	BEIS	2,5	G1	10	NO	
091065RUSPELC	45x12	CARAMELO	2,5	G1	10	NO	
091065RUSPELBA	45x12	BLANCO	2,5	G1	10	NO	
091065RUSPELNB	45x12	NEGRO	2,5	G1	10	NO	
091065RUSPELMB	45x12	MARRÓN OSC.	2,5	G1	10	NO	
091065RUSPELMAR	45x12	MARFIL	2,5	G1	10	NO	
091065RUSPELCU	45x12	CUERO	2,5	G1	10	NO	
091065RUSPELGR	45x12	GRIS	2,5	G1	10	NO	
091065RUSPELCR	45x12	CREMA	2,5	G1	10	NO	











**GUARDACANTOS PVC**  
PVC EDGE GUARD / PARE-BRISE EN PVC

REFERENCIA REFERENCE RÉFÉRENCE	MEDIDAS (mm) MEASURES (mm) MESURE (mm)	ACABADO FINISH FINITION	LONGITUD (m) LENGTH (m) LONGUEUR (m)	CAJA* BOX* BOITE*	UDS. CAJA UDS. BOX UDS. BOITE	PALETS	
						CAJAS	UDS
09GUABL260ECO	10x12,5	BLANCO ECO	2,6 m	E	100	60	6000
09GUABL260	10x12,5	BLANCO EXTRA	2,6 m	E	100	60	6000
09GUACLBEIGE260	10x12,5	BEIS	2,6 m	E	100	60	6000
09GUACLVERDE260	10x12,5	VERDE	2,6 m	E	100	60	6000
09GUACLMACLARO260	10x12,5	MARRON CLARO	2,6 m	E	100	60	6000
09GUACLNEGRO260	10x12,5	NEGRO	2,6 m	E	100	60	6000
09GUACLMAOSCURO260	10x12,5	MARRÓN OSC.	2,6 m	E	100	60	6000
09GUACLMARFIL263	10x12,5	MARFIL	2,6 m	E	100	60	6000
09GUACLAZUL260	10x12,5	AZUL	2,6 m	E	100	60	6000
09GUACLGRIS260	10x12,5	GRIS	2,6 m	E	100	60	6000



-  Caramelo  
RAL 8004
-  Beige  
RAL 1011
-  Crema  
RAL 9001
-  Marfil  
RAL 1013
-  Cuero  
RAL 1015
-  Marrón oscuro  
RAL 8011
-  Gris  
RAL 7046
-  Blanco  
RAL 9003
-  Negro  
RAL 9004

-  Beis  
RAL 1013
-  Azul  
RAL 5022
-  Blanco  
RAL 9003
-  Negro  
RAL 9005
-  Gris  
RAL 7035
-  Marrón claro  
RAL 8001
-  Marfil  
RAL 1015
-  Verde  
RAL 6005
-  Marrón oscuro  
RAL 8011

\*Para ver las características del modelo de caja ir a la página 40.



**PERFIL CUADRADO ACERO INOX CALIDAD 304**

SQUARE PROFILE STAINLESS STEEL QUALITY 304 / PROFIL CARRÉ QUALITÉ ACIER INOXYDABLE 304

REFERENCIA REFERENCE RÉFÉRENCE	MEDIDAS (mm) MEASURES (mm) MESURE (mm)	ACABADO FINISH FINITION	LONGITUD (m) LENGTH (m) LONGUEUR (m)	TUBO* TUBE* TUBE*	UDS. TUBO UDS. TUBE UDS. TUBE	PALETS	
						CAJAS	UDS
<b>11PCAC304125B</b>	12,5X12,5	BRILLO	2,6	M	20	NO	
<b>11PCAC304125M</b>	12,5X12,5	MATE	2,6	M	20	NO	
<b>11PCAC304125C</b>	12,5X12,5	CEPILLADO	2,6	M	20	NO	
<b>11PCAC304165B</b>	16X16	BRILLO	2,6	M1	14	NO	
<b>11PCAC304165M</b>	16X16	MATE	2,6	M1	14	NO	
<b>11PCAC304165C</b>	16X16	CEPILLADO	2,6	M1	14	NO	

\* El embalaje es un tubo de cartón reforzado

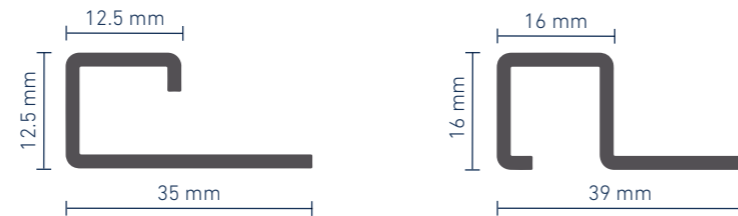

**PERFIL CUADRADO ACERO INOX CALIDAD 304**

SQUARE PROFILE STAINLESS STEEL QUALITY 304 / PROFIL CARRÉ QUALITÉ ACIER INOXYDABLE 304

REFERENCIA REFERENCE RÉFÉRENCE	MEDIDAS (mm) MEASURES (mm) MESURE (mm)	ACABADO FINISH FINITION	LONGITUD (m) LENGTH (m) LONGUEUR (m)	CAJA* BOX* BOITE*	UDS. CAJA UDS. BOX UDS. BOITE	PALETS	
						CAJAS	UDS
<b>11PCAC3042512B</b>	25X12	BRILLO	2,6	N	15	NO	
<b>11PCAC3042512M</b>	25X12	CEPILLADO	2,6	N1	15	NO	

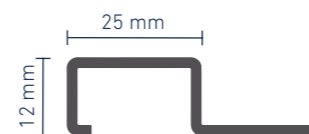

**GUARDACANTOS CURVO ACERO INOX CALIDAD 304**

CURVED EDGE GUARD STAINLESS STEEL QUALITY 304 /  
PROTECTEUR DE BORD COURBÉ EN ACIER INOXYDABLE DE QUALITÉ 304

REFERENCIA REFERENCE RÉFÉRENCE	MEDIDAS (mm) MEASURES (mm) MESURE (mm)	ACABADO FINISH FINITION	LONGITUD (m) LENGTH (m) LONGUEUR (m)	TUBO* TUBE* TUBE*	UDS. TUBO UDS. TUBE UDS. TUBE	PALETS	
						CAJAS	UDS
<b>11GCACE304105B</b>	10,5	BRILLO	2,6	M3	30	NO	
<b>11GCACE304105M</b>	10,5	MATE	2,6	M3	30	NO	
<b>11GCACE304125B</b>	12,5	BRILLO	2,6	M1	25	NO	
<b>11GCACE304125M</b>	12,5	MATE	2,6	M1	25	NO	

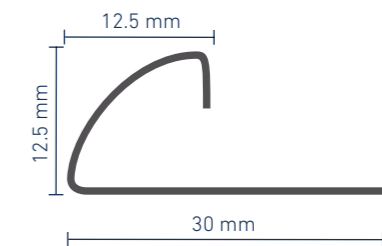

**PERFIL PLANO ACERO INOX CALIDAD 304**

FLAT PROFILE STAINLESS STEEL QUALITY 304  
PROFIL PLAT QUALITÉ ACIER INOXYDABLE 304

REFERENCIA REFERENCE RÉFÉRENCE	MEDIDAS (mm) MEASURES (mm) MESURE (mm)	ACABADO FINISH FINITION	LONGITUD (m) LENGTH (m) LONGUEUR (m)	TUBO* TUBE* TUBE*	UDS. TUBO UDS. TUBE UDS. TUBE	PALETS	
						TUBO	UDS
<b>11PPLAAC30413B</b>	13	BRILLO	2,6	M2	50	NO	
<b>11PPLAAC30413M</b>	13	MATE	2,6	M2	50	NO	

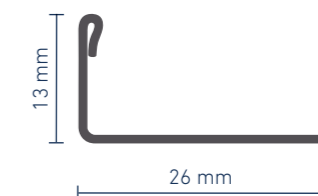

**GUARDACANTOS CURVO ALUMINIO**

ALUMINIUM CURVED EDGE GUARD / PROTÈGE-ARÊTE COURBÉ EN ALUMINIUM

REFERENCIA REFERENCE RÉFÉRENCE	MEDIDAS (mm) MEASURES (mm) MESURE (mm)	ACABADO FINISH FINITION	LONGITUD (m) LENGTH (m) LONGUEUR (m)	CAJA* BOX* BOITE*	UDS. CAJA UDS. BOX UDS. BOITE	PALETS	
						CAJAS	UDS
<b>11GCALUPB125</b>	12,5	BRILLO	2,6 m	P	50	NO	
<b>11GCALUPM125</b>	12,5	MATE	2,6 m	P	50	NO	
<b>11GCALUPBL125</b>	12,5	BLANCO	2,6 m	P	50	NO	
<b>11GCALUPN125</b>	12,5	NEGRO	2,6 m	P	50	NO	
<b>11GCALUPBR125</b>	12,5	BRONCE	2,6 m	P	50	NO	

\*Los perfiles lacados solo para interior.

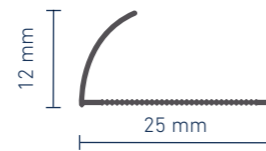

**GUARDACANTOS PLANO ALUMINIO**

ALUMINIUM FLAT EDGE GUARD / PROTECTEUR DE BORD PLAT EN ALUMINIUM

REFERENCIA REFERENCE RÉFÉRENCE	MEDIDAS (mm) MEASURES (mm) MESURE (mm)	ACABADO FINISH FINITION	LONGITUD (m) LENGTH (m) LONGUEUR (m)	CAJA* BOX* BOITE*	UDS. CAJA UDS. BOX UDS. BOITE	PALETS	
						CAJAS	UDS
<b>11GCPALUPB12</b>	12,0	BLANCO	2,6 m	Q	50	NO	
<b>11GCPALUPB125</b>	12,0	BRILLO	2,6 m	Q	50	NO	
<b>11GCPALUPM125</b>	12,0	MATE	2,6 m	Q	50	NO	
<b>11GCPALUPM126</b>	12,0	NEGRO	2,6 m	Q	50	NO	
<b>11GCPALUPM127</b>	12,0	BRONCE	2,6 m	Q	50	NO	

\*Los perfiles lacados solo para interior.

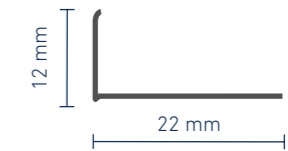

**GUARDACANTO SLIM ALUMINIO**

ALUMINIUM SLIM EDGE GUARD / PROTECTEUR DE BORD MINCE EN ALUMINIUM

REFERENCIA REFERENCE RÉFÉRENCE	MEDIDAS (mm) MEASURES (mm) MESURE (mm)	ACABADO FINISH FINITION	LONGITUD (m) LENGTH (m) LONGUEUR (m)	CAJA* BOX* BOITE*	UDS. CAJA UDS. BOX UDS. BOITE	PALETS	
						CAJAS	UDS
<b>11GCSALUB45</b>	4,5	BRILLO	2,5	Q	50	NO	
<b>11GCSALUM45</b>	4,5	MATE	2,5	Q	50	NO	

\*Los perfiles lacados solo para interior.



**LISTERO ALUMINIO CANTO ROMO**

LISTERO ALUMINIUM CANTO ROMO / LISTERO ALUMINIUM CANTO ROMO

REFERENCIA REFERENCE RÉFÉRENCE	MEDIDAS (mm) MEASURES (mm) MESURE (mm)	ACABADO FINISH FINITION	LONGITUD (m) LENGTH (m) LONGUEUR (m)	CAJA BOX BOITE	UDS. CAJA UDS. BOX UDS. BOITE	PALETS	
						CAJAS	UDS
<b>11LIS12X12PTB</b>	12x12	BLANCO	2,6	0	50	NO	
<b>11LIS10X10PTB</b>	12x12	BRILLO	2,6	0	50	NO	
<b>11LIS10X10PTM</b>	12x12	MATE	2,6	0	50	NO	

\*Los perfiles lacados solo para interior.

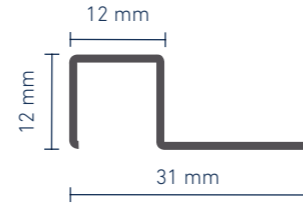

**LISTERO ALUMINIO**

LISTERO ALUMINIUM / LISTERO ALUMINIUM

REFERENCIA REFERENCE RÉFÉRENCE	MEDIDAS (mm) MEASURES (mm) MESURE (mm)	ACABADO FINISH FINITION	LONGITUD (m) LENGTH (m) LONGUEUR (m)	CAJA BOX BOITE	UDS. CAJA UDS. BOX UDS. BOITE	PALETS	
						CAJAS	UDS
<b>LISTEALU5X12</b>	5X12	BRILLO	2,6	0	50	NO	
<b>LISTALUMAT5X12</b>	5X12	MATE	2,6	0	50	NO	

\*Los perfiles lacados solo para interior.

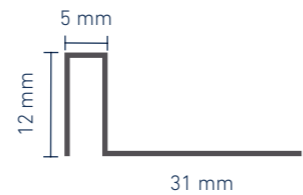

**LISTERO ALUMINIO CANTO ROMO**

LISTERO ALUMINIUM CANTO ROMO / LISTERO ALUMINIUM CANTO ROMO

REFERENCIA REFERENCE RÉFÉRENCE	MEDIDAS (mm) MEASURES (mm) MESURE (mm)	ACABADO FINISH FINITION	LONGITUD (m) LENGTH (m) LONGUEUR (m)	CAJA BOX BOITE	UDS. CAJA UDS. BOX UDS. BOITE	PALETS	
						CAJAS	UDS
<b>LISTEALU25X12</b>	25X12	BRILLO	2,6	01	50	NO	
<b>LISTALUMAT25</b>	25X12	MATE	2,6	01	50	NO	

\*Los perfiles lacados solo para interior.

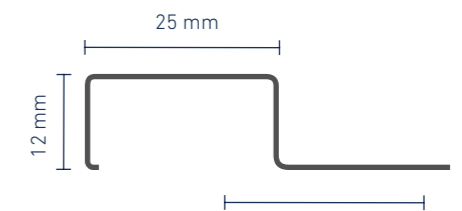

**LISTERO SLIM ALUMINIO**

LISTERO SLIM ALUMINIUM / LISTERO SLIM ALUMINIUM

REFERENCIA REFERENCE RÉFÉRENCE	MEDIDAS (mm) MEASURES (mm) MESURE (mm)	ACABADO FINISH FINITION	LONGITUD (m) LENGTH (m) LONGUEUR (m)	CAJA BOX BOITE	UDS. CAJA UDS. BOX UDS. BOITE	PALETS	
						CAJAS	UDS
<b>LISTEALU45B</b>	4,5	BRILLO	2,5	Q	50	NO	
<b>LISTEALU45M</b>	4,5	MATE	2,5	Q	50	NO	

\*Los perfiles lacados solo para interior.



**JUNTA DILATACIÓN ALUMINIO TIPO "T"**  
 ALUMINUM "T" TYPE EXPANSION JOINT  
 JOINT DE DILATATION EN ALUMINIUM DE TYPE "T"

REFERENCIA REFERENCE RÉFÉRENCE	MEDIDAS (mm) MEASURES (mm) MESURE (mm)	ACABADO FINISH FINITION	LONGITUD (m) LENGTH (m) LONGUEUR (m)	CAJA BOX BOITE	UDS. CAJA UDS. BOX UDS. BOITE	PALETS	
						CAJAS	UDS
<b>11JDAL10X12,5</b>	10X12,5	GRIS CLARO	2,5	0	20	NO	
<b>11JDAL10X15</b>	10X15	GRIS CLARO	2,5	0	20	NO	
<b>11JDAL15X12,5</b>	15X12,5	GRIS CLARO	2,5	0	20	NO	
<b>11JDAL15X15</b>	15X15	GRIS CLARO	2,5	0	20	NO	

\*Los perfiles lacados solo para interior.

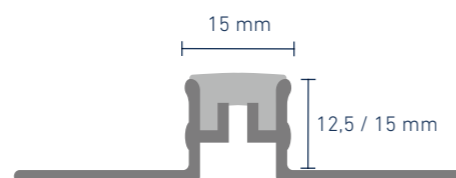

**RECAMBIO JUNTA DILATACIÓN ALUMINIO TIPO "T"**  
 REPLACEMENT ALUMINIUM EXPANSION JOINT TYPE "T"  
 REMPLACEMENT DU JOINT DE DILATATION EN ALUMINIUM DE TYPE "T"

REFERENCIA REFERENCE RÉFÉRENCE	MEDIDAS (mm) MEASURES (mm) MESURE (mm)	ACABADO FINISH FINITION	LONGITUD (m) LENGTH (m) LONGUEUR (m)	CAJA BOX BOITE	UDS. CAJA UDS. BOX UDS. BOITE	PALETS	
						CAJAS	UDS
<b>11RJDAL15N</b>	15X12,5	NEGRO	1		20	NO	
<b>11RJDAL15M</b>	15x12,5	MARRÓN	1		20	NO	
<b>11RJDAL15B</b>	15X12,5	BEIGE	1		20	NO	
<b>11RJDAL15MA</b>	15X12,5	MARFIL	1		20	NO	
<b>11RJDAL15BL</b>	15X12,5	BLANCO	1		20	NO	

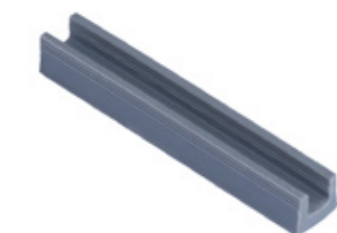
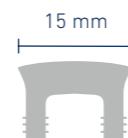

**CRUCETAS AZULEJO**  
 CROSSPIECE / TRAVERSE

REFERENCIA REFERENCE RÉFÉRENCE	MEDIDAS (mm) MEASURES (mm) MESURE (mm)	MATERIAL FINISH FINITION	CAJA* BOX* BOITE*	UDS. BOLSA UDS. BOX UDS. BOITE	UDS. CAJA UDS. BOX UDS. BOITE
<b>10CRUZ01</b>	1,0	PLÁSTICO	I	500	30.000
<b>10CRUZ02</b>	2,0	PLÁSTICO	11	200	20.000
<b>10CRUZ03</b>	3,0	PLÁSTICO	12	250	17.000
<b>10CRUZ05</b>	5,0	PLÁSTICO	13	250	15.000
<b>10CRUZ07</b>	7,0	PLÁSTICO	14	250	7.500
<b>10CRUZ10</b>	10,0	PLÁSTICO	15	250	5.000

**CUÑAS MACIZAS**  
 SOLID WEDGES / CALES PLEINES

REFERENCIA REFERENCE RÉFÉRENCE	MEDIDAS (mm) MEASURES (mm) MESURE (mm)	MATERIAL FINISH FINITION	CAJA* BOX* BOITE*	UDS. BOLSA UDS. BOX UDS. BOITE	UDS. CAJA UDS. BOX UDS. BOITE
<b>10CUÑAS</b>	CUÑAS	PLÁSTICO	J	500	20.000



**SEPARADOR PAVÉS**  
 PAVES SEPARATOR / SÉPARATEUR DE PAVÉS

REFERENCIA REFERENCE RÉFÉRENCE	MEDIDAS (mm) MEASURES MESURE	MATERIAL FINISH FINITION	CAJA BOX BOITE	UDS. BOLSA UDS. BOX UDS. BOITE	UDS. CAJA UDS. BOX UDS. BOITE
<b>10PAVES</b>	PAVES	PLÁSTICO	14	300	-



**CAJA EMBALAJE LARGA**



**TUBO DE ENVÍO**



**CAJA EMBALAJE PEQUEÑA**

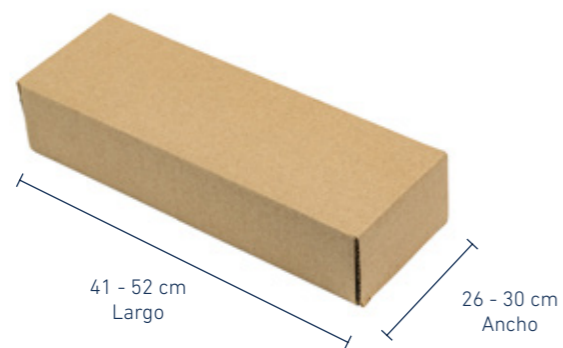

**CAJAS EMBALAJE LARGA**  
LARGE BOX / BOÎTE LONGUE

**TIPO A**

CAJAS							PALETS		
CAJA BOX BOITE	LARGO (cm) LANG (cm) LANGUE (cm)	ANCHO (cm) WIDE (cm) LARGUE (cm)	ALTO (cm) HIGH (cm) HAUTE (cm)	MEDIDA (cm) MEASURE (cm)	VOLUMEN (m³) VOLUME (m³) VOLUME (m³)	PESO (kg) WEIGHT (kg) POIDS (kg)	MEDIDA (cm) MEASURE (cm)	VOLUMEN (m³) VOLUME (m³) VOLUME (m³)	PESO (kg) WEIGHT (kg) PAIDS (kg)
<b>A</b>	255,0	25	7	250X25X7	0,045	25,000	255X110X120	3,366	1570,000
<b>A1</b>	265	25	7	260X25X7	0,042	26,000	265X110X120	3,500	1632,000
<b>A2</b>	275	25	7	270X25X7	0,043	27,000	275X110X120	3,630	1694,000
<b>A3</b>	285	25	7	280X25X7	0,045	28,000	285X110X120	3,762	1756,000
<b>A4</b>	305	25	7	300X25X7	0,048	30,000	300X110X120	3,960	1880,000

**TIPO B**

CAJAS							PALETS		
CAJA BOX BOITE	LARGO (cm) LANG (cm) LANGUE (cm)	ANCHO (cm) WIDE (cm) LARGUE (cm)	ALTO (cm) HIGH (cm) HAUTE (cm)	MEDIDA (cm) MEASURE (cm)	VOLUMEN (m³) VOLUME (m³) VOLUME (m³)	PESO (kg) WEIGHT (kg) POIDS (kg)	MEDIDA (cm) MEASURE (cm)	VOLUMEN (m³) VOLUME (m³) VOLUME (m³)	PESO (kg) WEIGHT (kg) PAIDS (kg)
<b>B</b>	250,0	28	8	250X28X8	0,056	18,500	260X120X50	1,560	575,000
<b>B1</b>	250,0	16	8	250X16X8	0,032	8,250	260X120X35	1,092	185,000
<b>B2</b>	250,0	28	8	250X28X8	0,056	11,000	260X120X50	1,560	240,000
<b>B3</b>	250,0	40	8	250X40X8	0,080	15,000	260X120X60	1,872	320,000
<b>B4</b>	250,0	40	8	250X40X8	0,080	20,000	260X120X70	2,184	420,000

**TIPO C**

CAJAS							PALETS		
CAJA BOX BOITE	LARGO (cm) LANG (cm) LANGUE (cm)	ANCHO (cm) WIDE (cm) LARGUE (cm)	ALTO (cm) HIGH (cm) HAUTE (cm)	MEDIDA (cm) MEASURE (cm)	VOLUMEN (m³) VOLUME (m³) VOLUME (m³)	PESO (kg) WEIGHT (kg) POIDS (kg)	MEDIDA (cm) MEASURE (cm)	VOLUMEN (m³) VOLUME (m³) VOLUME (m³)	PESO (kg) WEIGHT (kg) PAIDS (kg)
<b>C</b>	202,0	20	10	200X20X10	0,040	16,9	200X100X120	2,424	1034
<b>C1</b>	202,0	20	10	200X20X10	0,040	20,7	200X100X120	2,424	1262
<b>C2</b>	202,0	20	10	200X20X10	0,040	20,625	200X100X120	2,424	1257,5

\*Nota: Todos los pesos y medidas son orientativos.

TIPO D

CAJAS							PALETS		
CAJA BOX BOITE	LARGO (cm) LANG (cm) LANGUE (cm)	ANCHO (cm) WIDE (cm) LARGUE (cm)	ALTO (cm) HIGH (cm) HAUTE (cm)	MEDIDA (cm) MEASURE (cm)	VOLUMEN (m³) VOLUME (m³) VOLUME (m³)	PESO (kg) WEIGHT (kg) POIDS (kg)	MEDIDA (cm) MEASURE (cm)	VOLUMEN (m³) VOLUME (m³) VOLUME (m³)	PESO (kg) WEIGHT (kg) PAIDS (kg)
<b>D</b>	250,0	29	7	250X29X7	0,05075	17,500	250X110X120	3,300	860,000

TIPO E

CAJAS							PALETS		
CAJA BOX BOITE	LARGO (cm) LANG (cm) LANGUE (cm)	ANCHO (cm) WIDE (cm) LARGUE (cm)	ALTO (cm) HIGH (cm) HAUTE (cm)	MEDIDA (cm) MEASURE (cm)	VOLUMEN (m³) VOLUME (m³) VOLUME (m³)	PESO (kg) WEIGHT (kg) POIDS (kg)	MEDIDA (cm) MEASURE (cm)	VOLUMEN (m³) VOLUME (m³) VOLUME (m³)	PESO (kg) WEIGHT (kg) PAIDS (kg)
<b>E</b>	263,0	22	8	263x22x8	0,046288	23,000	—	—	—

TIPO F

CAJAS							PALETS		
CAJA BOX BOITE	LARGO (cm) LANG (cm) LANGUE (cm)	ANCHO (cm) WIDE (cm) LARGUE (cm)	ALTO (cm) HIGH (cm) HAUTE (cm)	MEDIDA (cm) MEASURE (cm)	VOLUMEN (m³) VOLUME (m³) VOLUME (m³)	PESO (kg) WEIGHT (kg) POIDS (kg)	MEDIDA (cm) MEASURE (cm)	VOLUMEN (m³) VOLUME (m³) VOLUME (m³)	PESO (kg) WEIGHT (kg) PAIDS (kg)
<b>F</b>	9,0	4	4	90X4	0,000144	20	—	—	—

TIPO G

CAJAS							PALETS		
CAJA BOX BOITE	LARGO (cm) LANG (cm) LANGUE (cm)	ANCHO (cm) WIDE (cm) LARGUE (cm)	ALTO (cm) HIGH (cm) HAUTE (cm)	MEDIDA (cm) MEASURE (cm)	VOLUMEN (m³) VOLUME (m³) VOLUME (m³)	PESO (kg) WEIGHT (kg) POIDS (kg)	MEDIDA (cm) MEASURE (cm)	VOLUMEN (m³) VOLUME (m³) VOLUME (m³)	PESO (kg) WEIGHT (kg) PAIDS (kg)
<b>G</b>	255,0	16	9	255X16X9	0,03672	18	—	—	—
<b>G1</b>	265	16	9	265X16X9	0,03816	22	—	—	—

TIPO H

CAJAS							PALETS		
CAJA BOX BOITE	LARGO (cm) LANG (cm) LANGUE (cm)	ANCHO (cm) WIDE (cm) LARGUE (cm)	ALTO (cm) HIGH (cm) HAUTE (cm)	MEDIDA (cm) MEASURE (cm)	VOLUMEN (m³) VOLUME (m³) VOLUME (m³)	PESO (kg) WEIGHT (kg) POIDS (kg)	MEDIDA (cm) MEASURE (cm)	VOLUMEN (m³) VOLUME (m³) VOLUME (m³)	PESO (kg) WEIGHT (kg) PAIDS (kg)
<b>H</b>	255,0	18	10	255x18x10	0,0459	27	—	—	—

TIPO N

CAJAS							PALETS		
CAJA BOX BOITE	LARGO (cm) LANG (cm) LANGUE (cm)	ANCHO (cm) WIDE (cm) LARGUE (cm)	ALTO (cm) HIGH (cm) HAUTE (cm)	MEDIDA (cm) MEASURE (cm)	VOLUMEN (m³) VOLUME (m³) VOLUME (m³)	PESO (kg) WEIGHT (kg) POIDS (kg)	MEDIDA (cm) MEASURE (cm)	VOLUMEN (m³) VOLUME (m³) VOLUME (m³)	PESO (kg) WEIGHT (kg) PAIDS (kg)
<b>N</b>	266,0	12	6	264x12x6	0,019152	13	—	—	—

TIPO O

CAJAS							PALETS		
CAJA BOX BOITE	LARGO (cm) LANG (cm) LANGUE (cm)	ANCHO (cm) WIDE (cm) LARGUE (cm)	ALTO (cm) HIGH (cm) HAUTE (cm)	MEDIDA (cm) MEASURE (cm)	VOLUMEN (m³) VOLUME (m³) VOLUME (m³)	PESO (kg) WEIGHT (kg) POIDS (kg)	MEDIDA (cm) MEASURE (cm)	VOLUMEN (m³) VOLUME (m³) VOLUME (m³)	PESO (kg) WEIGHT (kg) PAIDS (kg)
<b>O</b>	264,0	15	9	264X15X9	0,03564	12	—	—	—
<b>O1</b>	264	20	9	265X20X9	0,04752	14	—	—	—

TIPO P

CAJAS							PALETS		
CAJA BOX BOITE	LARGO (cm) LANG (cm) LANGUE (cm)	ANCHO (cm) WIDE (cm) LARGUE (cm)	ALTO (cm) HIGH (cm) HAUTE (cm)	MEDIDA (cm) MEASURE (cm)	VOLUMEN (m³) VOLUME (m³) VOLUME (m³)	PESO (kg) WEIGHT (kg) POIDS (kg)	MEDIDA (cm) MEASURE (cm)	VOLUMEN (m³) VOLUME (m³) VOLUME (m³)	PESO (kg) WEIGHT (kg) PAIDS (kg)
<b>P</b>	264,0	16	5	—	0,02112	13	—	—	—

TIPO Q

CAJAS							PALETS		
CAJA BOX BOITE	LARGO (cm) LANG (cm) LANGUE (cm)	ANCHO (cm) WIDE (cm) LARGUE (cm)	ALTO (cm) HIGH (cm) HAUTE (cm)	MEDIDA (cm) MEASURE (cm)	VOLUMEN (m³) VOLUME (m³) VOLUME (m³)	PESO (kg) WEIGHT (kg) POIDS (kg)	MEDIDA (cm) MEASURE (cm)	VOLUMEN (m³) VOLUME (m³) VOLUME (m³)	PESO (kg) WEIGHT (kg) PAIDS (kg)
<b>Q</b>	264,0	10	6	—	0,01584	11	—	—	—

TIPO T

CAJAS							PALETS		
CAJA BOX BOITE	LARGO (cm) LANG (cm) LANGUE (cm)	ANCHO (cm) WIDE (cm) LARGUE (cm)	ALTO (cm) HIGH (cm) HAUTE (cm)	MEDIDA (cm) MEASURE (cm)	VOLUMEN (m³) VOLUME (m³) VOLUME (m³)	PESO (kg) WEIGHT (kg) POIDS (kg)	MEDIDA (cm) MEASURE (cm)	VOLUMEN (m³) VOLUME (m³) VOLUME (m³)	PESO (kg) WEIGHT (kg) PAIDS (kg)
<b>T</b>	200,0	13	13	200X13	0,034	8,000	200X100X130	2,600	500,000
<b>T1</b>	300,0	13	13	300X13	0,051	12,000	300X120X130	4,680	740,000
<b>T2</b>	200,0	19	19	200X19X19	0,034	9,500	200X110X140	3,080	590,000
<b>T3</b>	300,0	19	19	300X19X19	0,051	14,250	300X120X140	5,040	875,000

## TIPO U

CAJAS							PALETS		
CAJA BOX BOITE	LARGO (cm) LANG (cm) LANGUE (cm)	ANCHO (cm) WIDE (cm) LARGUE (cm)	ALTO (cm) HIGH (cm) HAUTE (cm)	MEDIDA (cm) MEASURE (cm)	VOLUMEN (m³) VOLUME (m³) VOLUME (m³)	PESO (kg) WEIGHT (kg) POIDS (kg)	MEDIDA (cm) MEASURE (cm)	VOLUMEN (m³) VOLUME (m³) VOLUME (m³)	PESO (kg) WEIGHT (kg) PAIDS (kg)
<b>U</b>	300,0	28	8	300X28X8	0,067	24,000	300X110X165	5,445	1124,000

## TIPO Y

CAJAS							PALETS		
CAJA BOX BOITE	LARGO (cm) LANG (cm) LANGUE (cm)	ANCHO (cm) WIDE (cm) LARGUE (cm)	ALTO (cm) HIGH (cm) HAUTE (cm)	MEDIDA (cm) MEASURE (cm)	VOLUMEN (m³) VOLUME (m³) VOLUME (m³)	PESO (kg) WEIGHT (kg) POIDS (kg)	MEDIDA (cm) MEASURE (cm)	VOLUMEN (m³) VOLUME (m³) VOLUME (m³)	PESO (kg) WEIGHT (kg) PAIDS (kg)
<b>Y</b>	255,0	25	7	255X25X7	0,045	12,500	255X110X120	3,366	795,000
<b>Y1</b>	265,0	25	7	265X25X7	0,042	12,500	265X110X120	3,500	795,000

CAJAS EMBAJALE PEQUEÑA  
SMALL BOX / PETITE BOÎTE

## TIPO I

CAJAS							PALETS		
CAJA BOX BOITE	LARGO (cm) LANG (cm) LANGUE (cm)	ANCHO (cm) WIDE (cm) LARGUE (cm)	ALTO (cm) HIGH (cm) HAUTE (cm)	MEDIDA (cm) MEASURE (cm)	VOLUMEN (m³) VOLUME (m³) VOLUME (m³)	PESO (kg) WEIGHT (kg) POIDS (kg)	MEDIDA (cm) MEASURE (cm)	VOLUMEN (m³) VOLUME (m³) VOLUME (m³)	PESO (kg) WEIGHT (kg) PAIDS (kg)
<b>I</b>	50,0	30	40		0,06	5	-	-	-
<b>I1</b>	50,0	30	40		0,06	9	-	-	-
<b>I2</b>	50,0	30	40		0,06	10	-	-	-
<b>I3</b>	50,0	30	40		0,06	11	-	-	-
<b>I4</b>	50,0	28	40		0,056	5	-	-	-

## TIPO J

CAJAS							PALETS		
CAJA BOX BOITE	LARGO (cm) LANG (cm) LANGUE (cm)	ANCHO (cm) WIDE (cm) LARGUE (cm)	ALTO (cm) HIGH (cm) HAUTE (cm)	MEDIDA (cm) MEASURE (cm)	VOLUMEN (m³) VOLUME (m³) VOLUME (m³)	PESO (kg) WEIGHT (kg) POIDS (kg)	MEDIDA (cm) MEASURE (cm)	VOLUMEN (m³) VOLUME (m³) VOLUME (m³)	PESO (kg) WEIGHT (kg) PAIDS (kg)
<b>J</b>	41,0	26	25	41X26X25	0,02665	9	-	-	-

## TIPO K

CAJAS							PALETS		
CAJA BOX BOITE	LARGO (cm) LANG (cm) LANGUE (cm)	ANCHO (cm) WIDE (cm) LARGUE (cm)	ALTO (cm) HIGH (cm) HAUTE (cm)	MEDIDA (cm) MEASURE (cm)	VOLUMEN (m³) VOLUME (m³) VOLUME (m³)	PESO (kg) WEIGHT (kg) POIDS (kg)	MEDIDA (cm) MEASURE (cm)	VOLUMEN (m³) VOLUME (m³) VOLUME (m³)	PESO (kg) WEIGHT (kg) PAIDS (kg)
<b>k</b>	50	27	34	50X27X34	0,0459	10	-	-	-
<b>k1</b>	52,0	28	40	52X28X40	0,05824	122	120X100X130	1,600	6100
<b>K2</b>	52,0	28	40	52X28X40	0,05824	70	120X100X130	1,600	3500
<b>K3</b>	52,0	28	40	52X28X40	0,05824	53	120X100X130	1,600	2650
<b>K4</b>	52,0	28	40	52X28X40	0,05824	44	120X100X130	1,600	1760
<b>K5</b>	52,0	28	40	52X28X40	0,05824	35	120X100X130	1,600	1400
<b>K6</b>	52,0	28	40	52X28X40	0,05824	27	120X100X130	1,600	1215
<b>K7</b>	52,0	28	40	52X28X40	0,05824	22	120X100X130	1,600	880
<b>K8</b>	52,0	28	40	52X28X40	0,05824	18	120X100X130	1,600	720

## TIPO L

CAJAS							PALETS		
BOLSA BAG SAC	LARGO (cm) LANG (cm) LANGUE (cm)	ANCHO (cm) WIDE (cm) LARGUE (cm)	ALTO (cm) HIGH (cm) HAUTE (cm)	MEDIDA (cm) MEASURE (cm)	VOLUMEN (m³) VOLUME (m³) VOLUME (m³)	PESO (kg) WEIGHT (kg) POIDS (kg)	MEDIDA (cm) MEASURE (cm)	VOLUMEN (m³) VOLUME (m³) VOLUME (m³)	PESO (kg) WEIGHT (kg) PAIDS (kg)
<b>L</b>	60	50	13	60x50x13	0,039	5	130X110X200	2,860	475
<b>L1</b>	60	50	13	60x50x13	0,039	2,9	130X110X200	2,860	330
<b>L2</b>	60	50	13	60x50x13	0,039	3,25	130X110X200	2,860	365
<b>L3</b>	60	50	13	60x50x13	0,039	3,25	130X110X200	2,860	365
<b>L4</b>	60	50	13	60x50x13	0,039	3,4	130X110X200	2,860	352
<b>L5</b>	60	50	13	60x50x13	0,039	2,55	130X110X200	2,860	290
<b>L6</b>	60	50	13	60x50x13	0,039	6,45	130X110X200	2,860	335
<b>L7</b>	67	30	30	67X30	0,0603	5,5	120X110X210	2,900	470

## TIPO R

CAJAS							PALETS		
BOLSA BAG SAC	LARGO (cm) LANG (cm) LANGUE (cm)	ANCHO (cm) WIDE (cm) LARGUE (cm)	ALTO (cm) HIGH (cm) HAUTE (cm)	MEDIDA (cm) MEASURE (cm)	VOLUMEN (m³) VOLUME (m³) VOLUME (m³)	PESO (kg) WEIGHT (kg) POIDS (kg)	MEDIDA (cm) MEASURE (cm)	VOLUMEN (m³) VOLUME (m³) VOLUME (m³)	PESO (kg) WEIGHT (kg) PAIDS (kg)
<b>R</b>	70	55	30	70x55x30	0,1155	5,2	130X110X180	2,574	180
<b>R1</b>	70	50	30	70x50x30	0,105	4,2	130X110X180	2,574	395
<b>R2</b>	40	59	40	49x59x40	0,0944	7	130X110X180	2,574	275
<b>R3</b>	80	40	20	80X40X20	0,064	5,2	-	-	-

## TIPO S

CAJAS							PALETS		
CAJA BOX BOITE	LARGO (cm) LANG (cm) LANGUE (cm)	ANCHO (cm) WIDE (cm) LARGUE (cm)	ALTO (cm) HIGH (cm) HAUTE (cm)	MEDIDA (cm) MEASURE (cm)	VOLUMEN (m³) VOLUME (m³) VOLUME (m³)	PESO (kg) WEIGHT (kg) POIDS (kg)	MEDIDA (cm) MEASURE (cm)	VOLUMEN (m³) VOLUME (m³) VOLUME (m³)	PESO (kg) WEIGHT (kg) PAIDS (kg)
<b>S</b>	40	30	15	40x30x15	0,018	7,6	130X110X170	2,440	255

## TIPO W

CAJAS							PALETS		
CAJA BOX BOITE	LARGO (cm) LANG (cm) LANGUE (cm)	ANCHO (cm) WIDE (cm) LARGUE (cm)	ALTO (cm) HIGH (cm) HAUTE (cm)	MEDIDA (cm) MEASURE (cm)	VOLUMEN (m³) VOLUME (m³) VOLUME (m³)	PESO (kg) WEIGHT (kg) POIDS (kg)	MEDIDA (cm) MEASURE (cm)	VOLUMEN (m³) VOLUME (m³) VOLUME (m³)	PESO (kg) WEIGHT (kg) PAIDS (kg)
<b>W</b>	100,0	13	13	100X13	0,017	2,125	120X100X155	2,046	264,375
<b>W1</b>	100,0	10	10	100X10	0,010	5	120X80X120	1,152	180

## TIPO X

CAJAS							PALETS		
CAJA BOX BOITE	LARGO (cm) LANG (cm) LANGUE (cm)	ANCHO (cm) WIDE (cm) LARGUE (cm)	ALTO (cm) HIGH (cm) HAUTE (cm)	MEDIDA (cm) MEASURE (cm)	VOLUMEN (m³) VOLUME (m³) VOLUME (m³)	PESO (kg) WEIGHT (kg) POIDS (kg)	MEDIDA (cm) MEASURE (cm)	VOLUMEN (m³) VOLUME (m³) VOLUME (m³)	PESO (kg) WEIGHT (kg) PAIDS (kg)
<b>X</b>	40,0	10	10	40X10X10	0,004	5	-	-	-
<b>X1</b>	40	13	13	40X13X10	0,007	6	-	-	-

## TUBOS DE ENVÍO

TUBE / TUBE

### TIPO M

CAJAS							PALETS		
CAJA BOX BOITE	LARGO (cm) LANG (cm) LANGUE (cm)	ANCHO (cm) WIDE (cm) LARGUE (cm)	ALTO (cm) HIGH (cm) HAUTE (cm)	MEDIDA (cm) MEASURE (cm)	VOLUMEN (m³) VOLUME (m³) VOLUME (m³)	PESO (kg) WEIGHT (kg) POIDS (kg)	MEDIDA (cm) MEASURE (cm)	VOLUMEN (m³) VOLUME (m³) VOLUME (m³)	PESO (kg) WEIGHT (kg) PAIDS (kg)
<b>M</b>	264,0	9	9	264x9	0,021384	14	-	-	-
<b>M1</b>	264,0	9	9	264x9	0,021384	15	-	-	-
<b>M2</b>	264,0	9	9	264x9	0,021384	18	-	-	-
<b>M3</b>	264,0	9	9	264x9	0,021384	24	-	-	-



# LISANPLAST S.L.

## EXTRUSION MATERIAS PLASTICAS

### CONDICIONES DE VENTA

Lisanplast podrá, por medio de sus agentes comerciales, confeccionar presupuestos personalizados, con una validez de 15 días salvo que se acuerden otras condiciones.

\*Lisanplast se reserva el dominio de los productos de venta hasta que estos hayan sido cobrados íntegramente.

\*La forma de pago será pactada entre el cliente y el agente comercial.

\*La presentación y el metraje de nuestros productos puede variar en función de las necesidades de cada cliente, reservándose Lisanplast el derecho a incrementar el precio de los mismos por este motivo.

\*Lisanplast ofrece la posibilidad de estudio de perfiles y juntas, según la necesidad de cada cliente, para su posterior fabricación.

### CONDICIONES DE TRANSPORTE Y PLAZOS DE ENTREGA

Lisanplast podrá, por medio de sus agentes comerciales, confeccionar presupuestos personalizados, con una validez de 15 días salvo que se acuerden otras condiciones.

\*Lisanplast garantiza el plazo de entrega pactado con sus agentes comerciales.

\*Los portes irán por cuenta de Lisanplast para pedidos por un importe superior a 600 €

\*El material viaja por cuenta y riesgo del comprador, siempre que se utilice como medio agencia de transportes, con independencia de que sea Lisanplast quien gestione dicho medio. En el caso de que la mercancía sea transportada por nuestros propios camiones, será Lisanplast quien asuma cualquier deficiencia en la misma.

### POLÍTICA DE DEVOLUCIONES

\*No se admitirán devoluciones de productos transcurridos 10 días desde la entrega de los mismos.

\*No se admitirán devoluciones de productos cuyo embalaje haya sido manipulado por el cliente.

\*Las devoluciones ajenas a la empresa, deberán ser autorizadas previamente por escrito por Lisanplast, abonándose el 80% del importe de venta, destinándose el 20% restante a la depreciación del producto.



Estamos en Autovía del Mediterráneo A-7, km 589  
(salida 588), Librilla (Murcia)

---

T - +34 968 657657

[www.lisanplast.com](http://www.lisanplast.com)